

2 RELAY - SEQUENCING RECEIVER

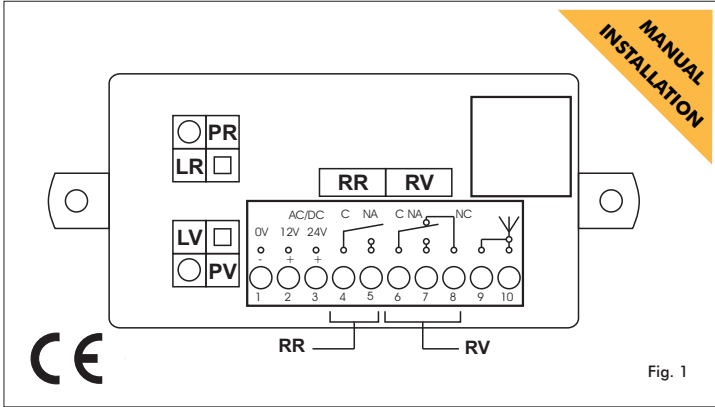

Fig. 1

Introduction

The receiver Erone type SEL2641R433-SQR is a superheterodyne single conversion receiver with integrated rolling-code decoding. The demodulation is AM/ASK. The receiver is equipped with 2x24VA relays which can work in sequence and with different (programmable) pulse times. It can be used for the wireless activation of a sequencing automatic doors. Hereby, CDVI Wireless Spa, declares that the radio equipment type SEL2641R433-SQR is in compliance with directive 2014/53/EU. The full text of the EU declaration of conformity is available at the following internet address: www.erone.com.

Technical specifications

Receiver type:	Superheterodyne.
Demodulation:	AM/ASK.
Operating frequency:	433,92 MHz.
Local oscillator frequency:	6,6128 MHz.
Intermediate frequency:	10,7 MHz.
Sensitivity (for good signal):	-115 dBm.
Input impedance:	50 Ohm.
Supply voltage :	12 or 24 V ac/dc.
Current consumption:	at rest: 25 mA with 1 relay excited: 55 mA
Number of relays:	2 (1NO, 1NO or NC).
Commutable max power:	24W or 24VA.
Max codes number:	85 transmitter keys.
Security protocol	Keeloq® Hopping code
Operating temperature:	from -20 to + 70 °C.
Dimensions:	105 x 45 x 28 mm.
Weight:	65 gr.
Pulse time	0,5 / 10 sec.
Delay time	1 - 30 sec.

OPERATING MODES

The receiver can operate in 3 different modes:

- 1) Pulse or Toggle Mode with Green Relay RV with adjustable hold time;
- 2) Pulse Mode with delayed activation of Red Relay RR;
- 3) Sequencing Mode with both relays activated (RR and RV) with adjustable delay time of RR for vestibule application.

Transmitter memorization

Each transmitter can be memorized on RR, or RV or RR & RV

LEGEND

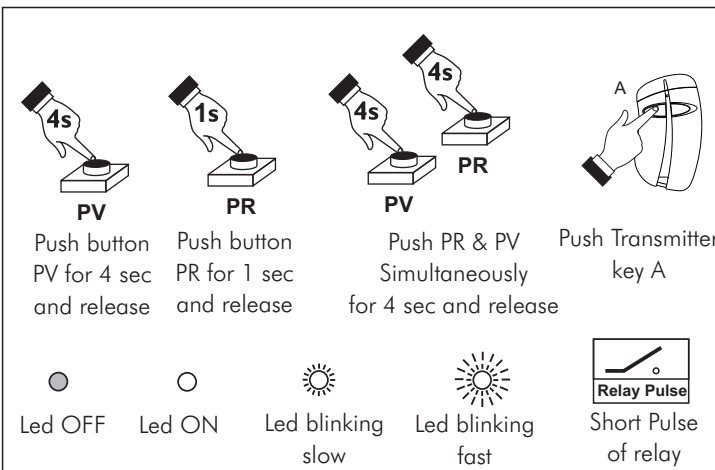

1 - MEMORIZATION on RR

If the transmitter is memorized on RR, the relay RR will be activated for 0,5 sec. after a delay (adjustable from 0 to 30 sec.).
Default time = 10 sec.

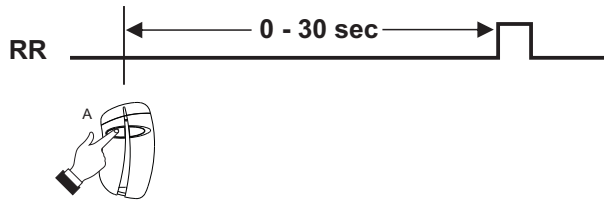

Procedure to memorize TX on RR

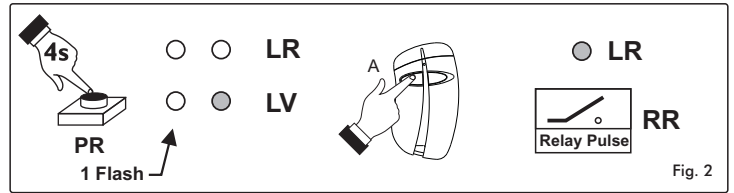
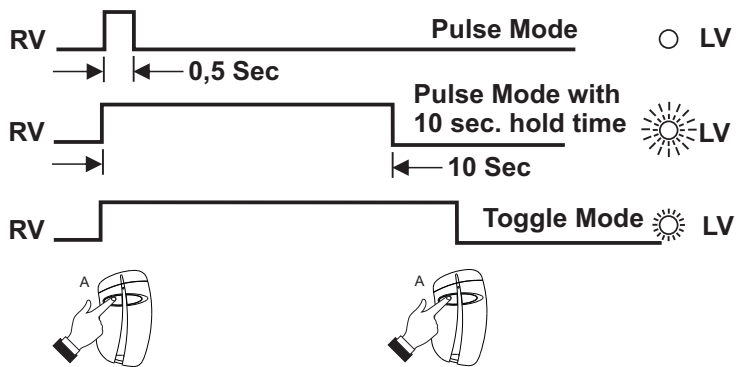

Fig. 2

2 - MEMORIZATION on RV

If the transmitter is memorized on RV, the relay RV will be activated in Pulse or Toggle mode at the reception of a valid code. The hold time of the pulse mode can be 0,5 or 10 sec.



Procedure to memorize TX on RV

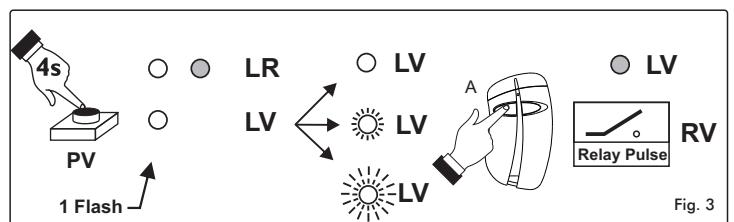
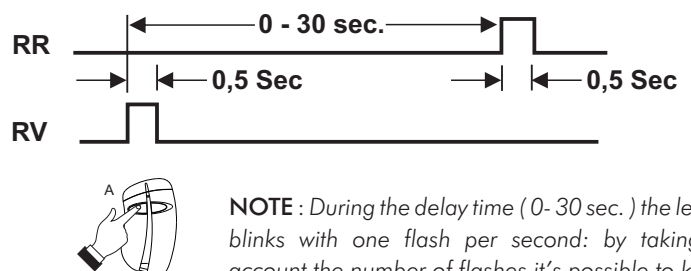

Fig. 3

NOTE : If a transmitter key has been memorized on RV cannot be memorized also on RR but only on RR & RV

3 - MEMORIZATION on RR & RV

If the transmitter is memorized using both the buttons PR and PV, both the relays RR and RV will be activated in pulse mode with the relay RR activated after a delay adjustable from 0 to 30 sec [default = 10 sec.]



NOTE : During the delay time (0- 30 sec.) the led LR blinks with one flash per second: by taking in account the number of flashes it's possible to know the delay set.

Procedure to memorize TX on RR & RV

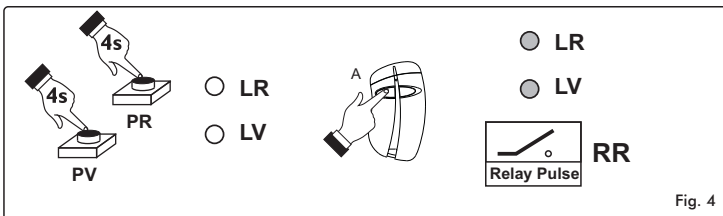

4 - CHANGE RV OPERATING MODE

PULSE ----> TOGGLE

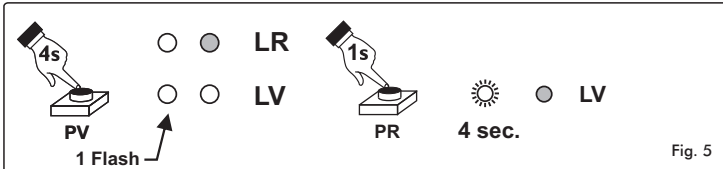

TOGGLE ----> PULSE

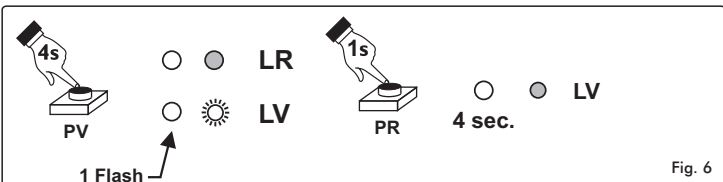

5 - CHANGE RV PULSE TIME

RV can have a pulse time of 0,5 sec (Default) or 10 sec.
The procedure to change from one value to the other can be followed only if the operating mode of RV is PULSE.
If RV is set in TOGGLE mode, change it to PULSE before commencing the procedure.

0,5 Sec. ----> 10 Sec.

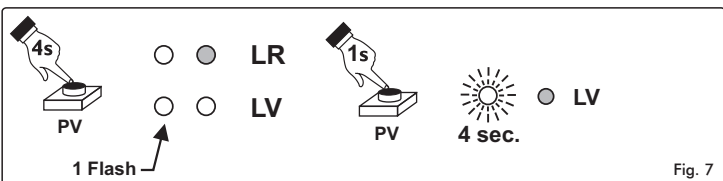

10 Sec. ----> 0,5 Sec.

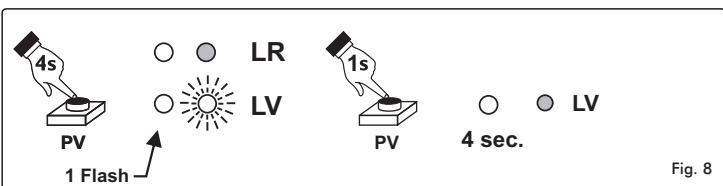

6 - CHANGE RR HOLD TIME

RR has always a pulse time of 0,5 sec (Default) but its activation occurs after the reception of the TX transmission with a delay time adjustable.
The set-in-factory value for the delay time is 10 Sec.
Follow the procedure below to adjust the delay desired.
The procedure can be carried out by knowing that:

PR : adds 1 sec at each pressure

PV : adds 5 sec at each pressure.

The max number of pressures available for each button is 5, so the max value for the delay is 30 sec.

Procedure

Before commencing the set-up of the delay time, identify the correct sequence of pressures needed, according to the value desired.

Examples:

PR - PR - PR - PR - PR = 1+1+1+1+1 = 5 sec

PR - PR - PV - PV = 1 + 1 + 5 + 5 = 12 sec

PR - PR - PR - PR - PR - PV - PV - PV - PV - PV = 5 + 25 = 30 sec.

At each pressures the led LR or LV will flash.

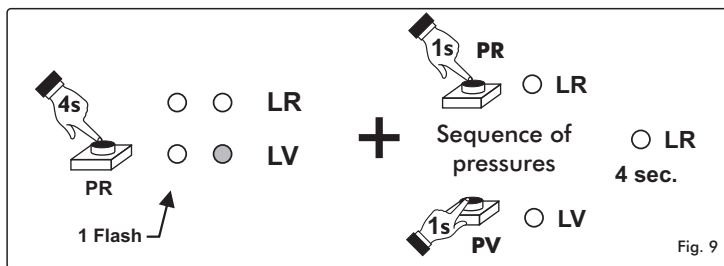

7 - RESTORE RELAYS DEFAULT MODES

It's possible to restore the default operating mode of both relays, setting RR with a delay of 10 Sec. and RV in pulse mode with hold time of 0,5 sec.

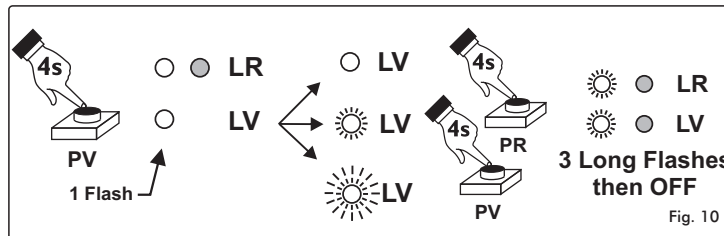

8 - MEMORY DELETE

Follow the procedures below to delete a single transmitter or the whole memory

8.1 - Delete a TX key from RV

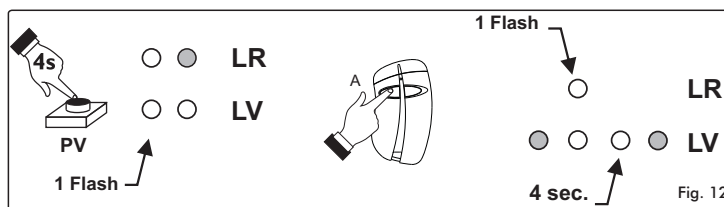

8.2 - Delete a TX key from RR

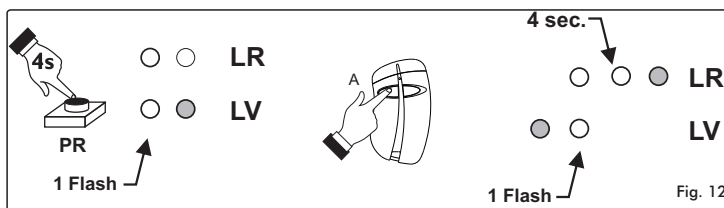

8.3 - Delete a TX key from RR & RV

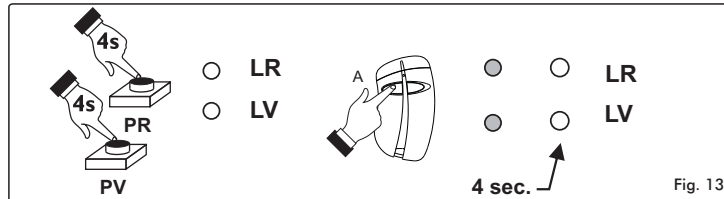

8.4 - Delete the full memory

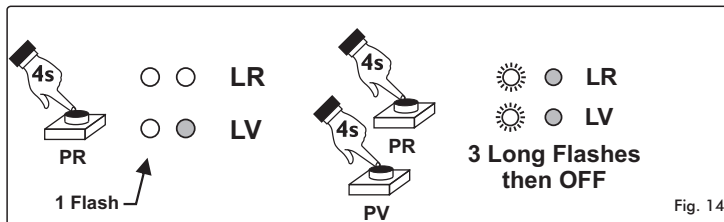

GUARANTEE

The warranty period of Erone receivers is 24 months, beginning from the manufacturing date of the transmitter. During this period, if the product doesn't operate correctly, due to a defective component, the product will be repaired or replaced at the sole discretion of the manufacturer. The warranty does not extend to the receiver case which can be damaged by conditions outside the control of the manufacturer.



Manufactured by CDVI Wireless Spa
Via Piave, 23 - 31020
San Pietro di Feletto (TV) - Italy
Tel. 0438.450860 - Fax. 0438.457126
e-mail: info@erone.com / Web: www.erone.com